



984P PLASTIC SNAP PLIERS

Instruction Guide for Size 20 Round, Star, Heart and
Flower Plastic Snaps



984P Plastic Snap Pliers – Round, Star and Heart Instructions

Fabric Preparation for Round, Star, and Heart Snaps

Use two layers of light to medium-weight fabric, reinforced with interfacing. Mark position of snaps on topside and underside of garment. Test a snap on swatch of fabric.

Instructions for Making Holes in Fabric



Remove protective cover from point of awl. Replace for storage.

Making Holes:

1. Center point of awl over mark.
2. Push awl through fabric to make a small hole.

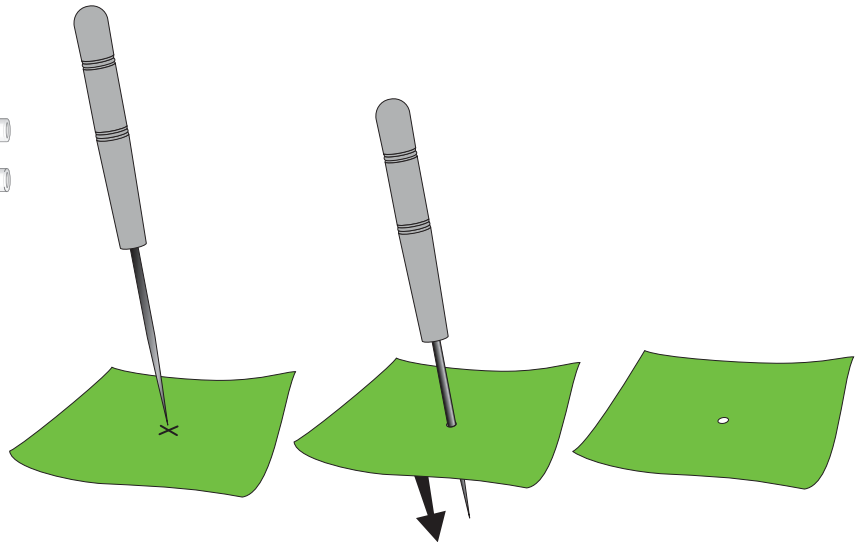

Instructions for Applying Round, Star and Heart Plastic Snaps

Snap Parts:

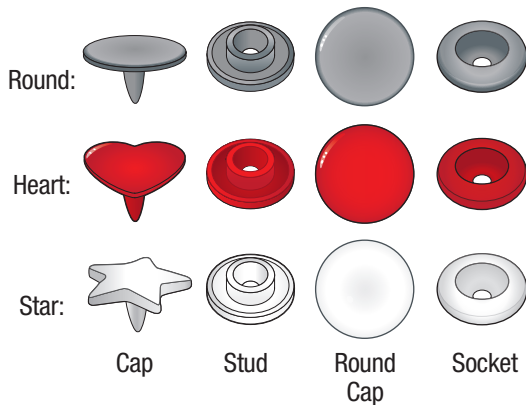

Pliers Tools:

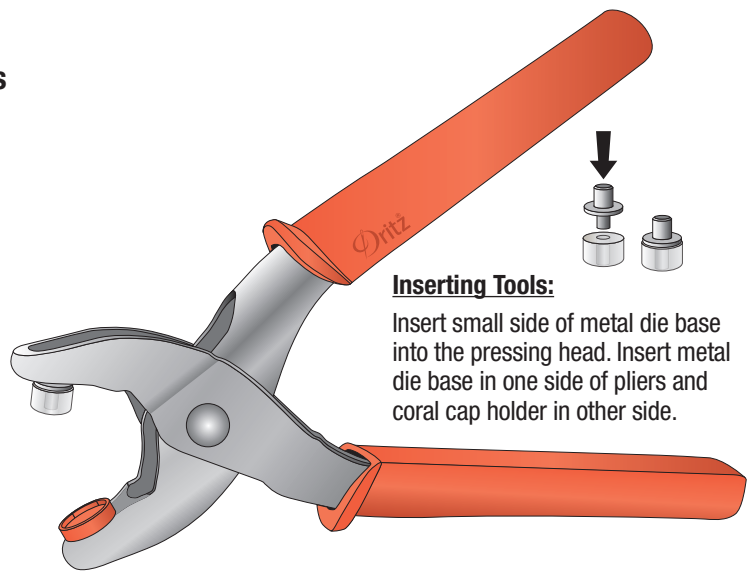
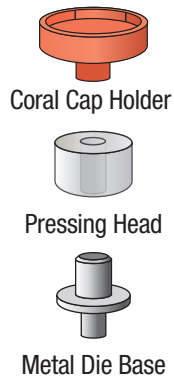

Inserting Tools:

Insert small side of metal die base into the pressing head. Insert metal die base in one side of pliers and coral cap holder in other side.

Applying Decorative Cap & Stud (Topside of garment):

1. Insert prong of decorative cap into hole.
2. Place stud over prong.
3. Position decorative cap in coral cap holder.
4. Squeeze pliers firmly to apply snap. Check for tightness; if necessary, rotate pliers and squeeze again to completely flatten post.

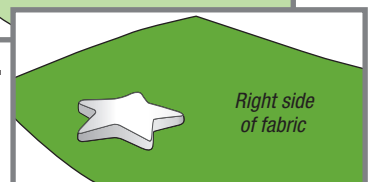
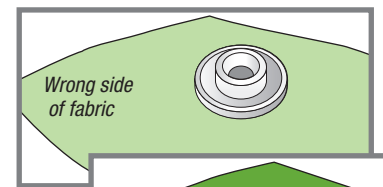
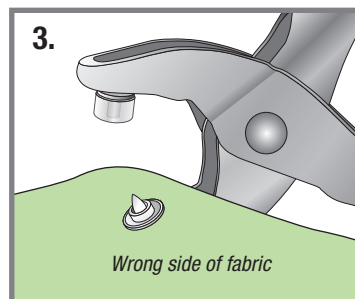
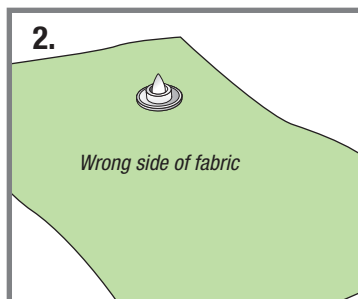
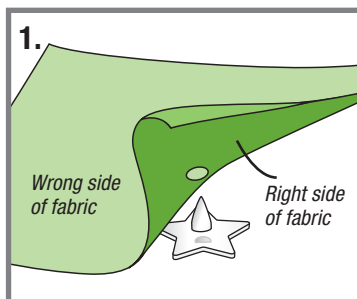

984P Plastic Snap Pliers – Round, Star and Heart Instructions (cont.)

Applying Round Cap & Socket (Underside of garment):

1. Insert prong of round cap into hole.
2. Place socket over prong.
3. Position round cap in coral cap holder.
4. Squeeze pliers firmly to apply snap. Check for tightness; squeeze again, if necessary.

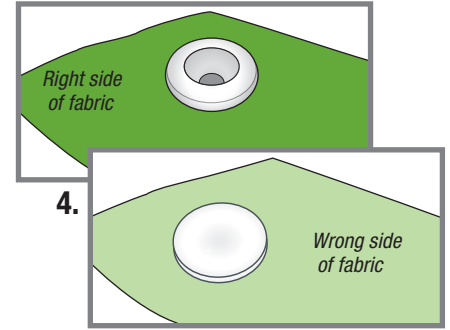
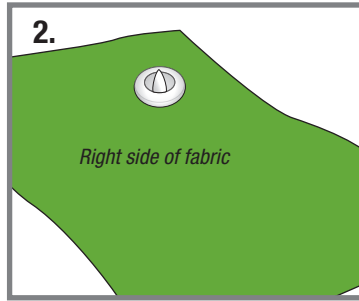
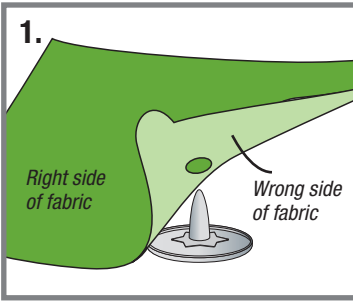

Removing Tools:

Slip hook of gray tool remover inside ledge of pliers and press down to release tool. Repeat for opposite side.

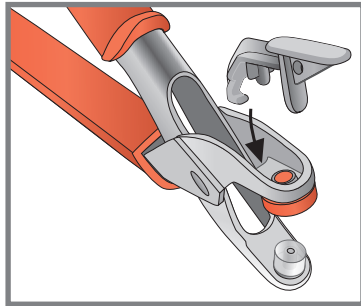

984P Plastic Snap Pliers – Flower Instructions

Fabric Preparation for Flower Plastic Snaps

Use two layers of light to medium-weight fabric, reinforced with interfacing. Mark position of snaps on topside and underside of garment. Test a snap on swatch of fabric.

Instructions for Making Holes in Fabric

Awl:



Protective Cover:

Remove protective cover from point of awl. Replace for storage.

Making Holes:

1. Center point of awl over mark.
2. Push awl through fabric to make a small hole.

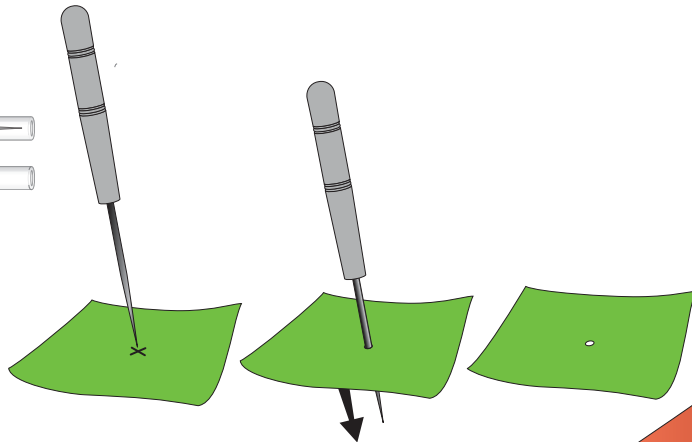

Instructions for Applying Flower Snaps

Snap Parts:



Pliers Tools:

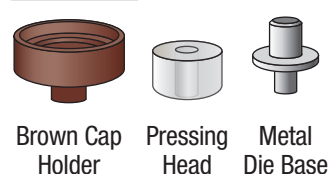

Inserting Tools:

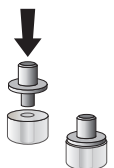

Insert small side of metal die base into the pressing head. Insert metal die base in one side of pliers and brown cap holder in other side.

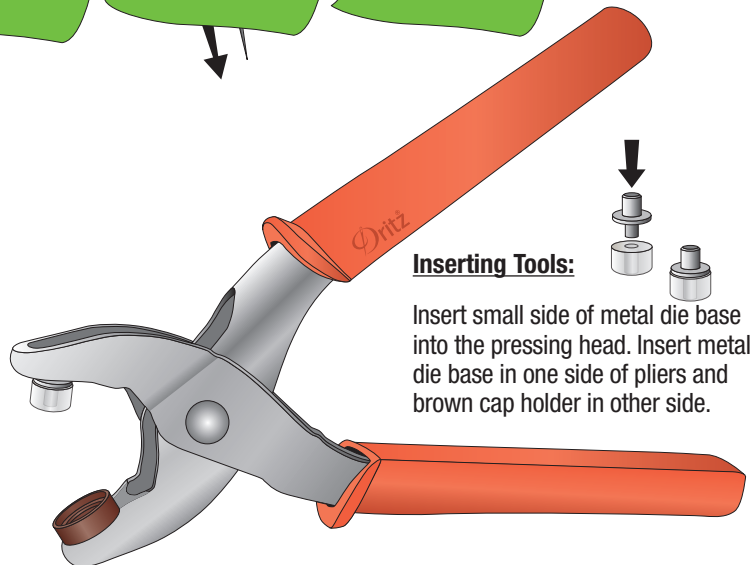

984P Plastic Snap Pliers – Flower Instructions (cont.)

Applying Decorative Cap & Stud (Topside of garment):

1. Insert prong of decorative cap into hole.
2. Place stud over prong.
3. Position decorative cap in brown cap holder.
4. Squeeze pliers firmly to apply snap. Check for tightness; if necessary, rotate pliers and squeeze again to completely flatten post.

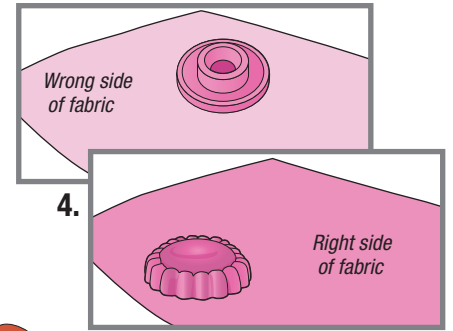
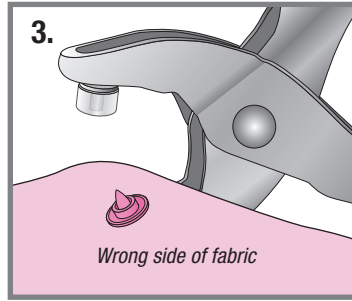
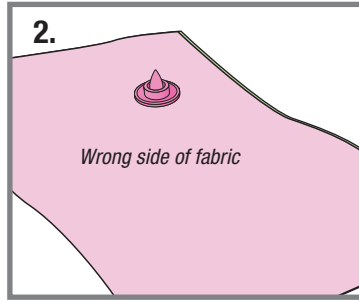
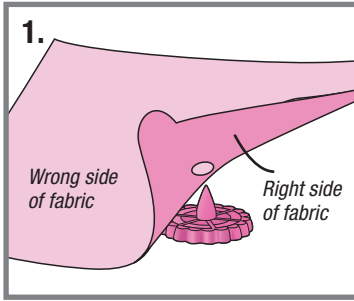

5. Remove brown cap holder after applying all decorative snaps. Metal die base will remain in tool. Slip hook of gray tool remover inside ledge of pliers and press down to release tool.

Inserting Tool:

Insert coral cap holder into pliers.

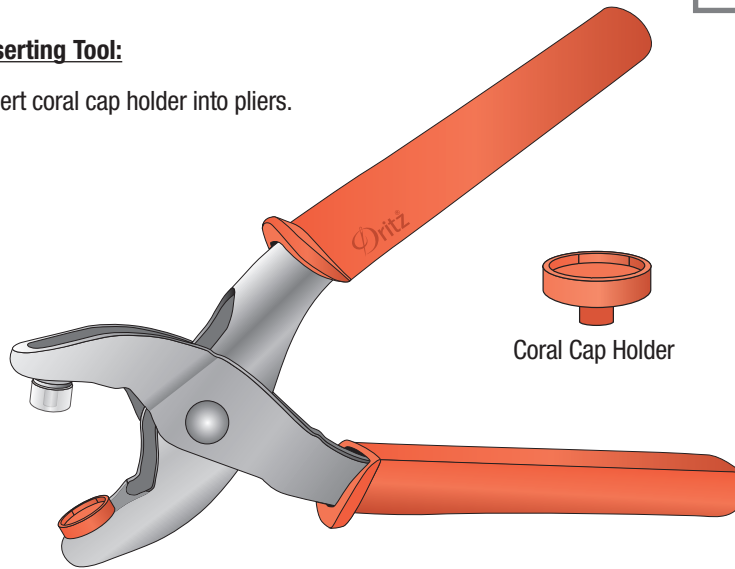
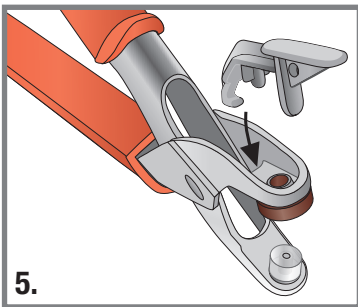

Applying Round Cap & Socket (Underside of garment):

1. Insert prong of round cap into hole.
2. Place socket over prong.
3. Position round cap in coral cap holder.
4. Squeeze pliers firmly to apply snap. Check for tightness; squeeze again, if necessary.

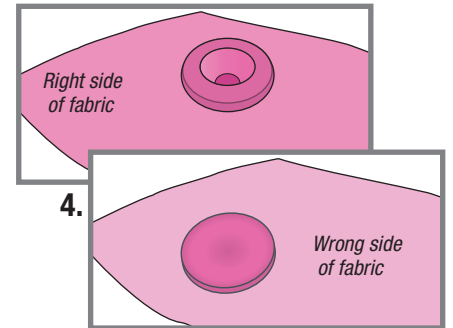
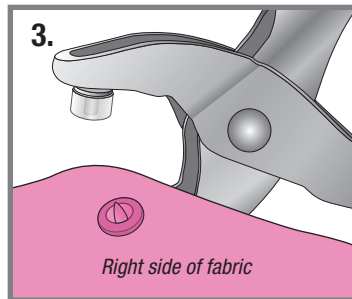
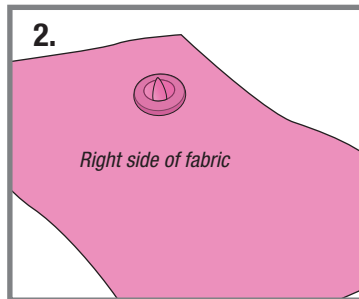
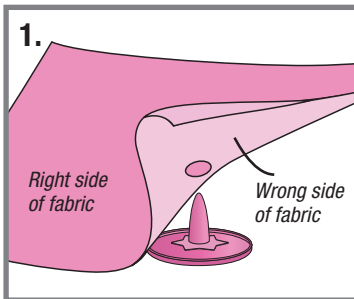

Removing Tools:

Slip hook of gray tool remover inside ledge of pliers and press down to release tool. Repeat for opposite side.

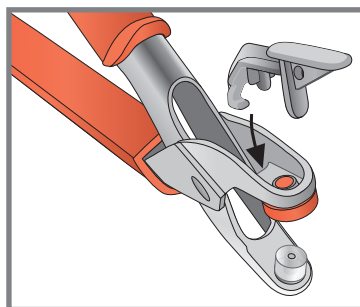

Additional Information

Storing Pliers

Squeeze pliers together and hook gray tool remover at top of pliers.

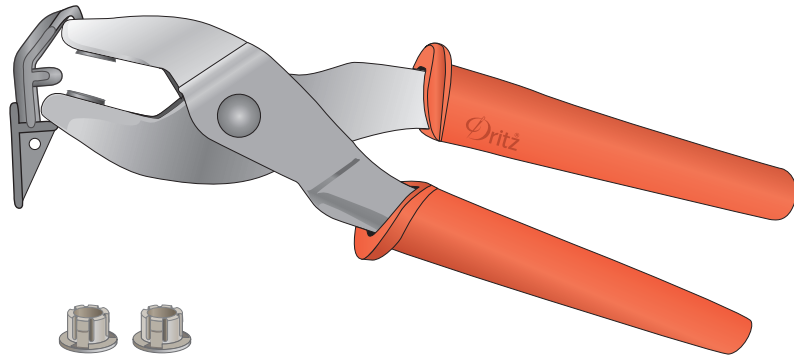

Replacement Inserts

Replacement inserts have been provided. When tools are no longer staying in pliers well, remove worn insert and replace with new.

WARNING: CHOKING HAZARD - SMALL PARTS. Keep away from children under 3.